

SJ lok litt T 21

Ritningarna
och 1:60 (N)

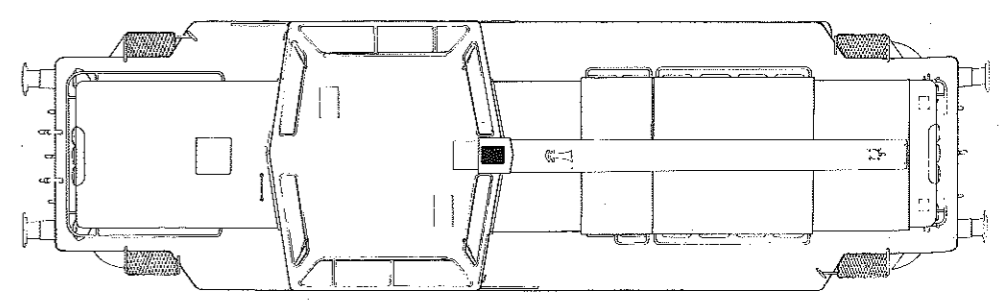

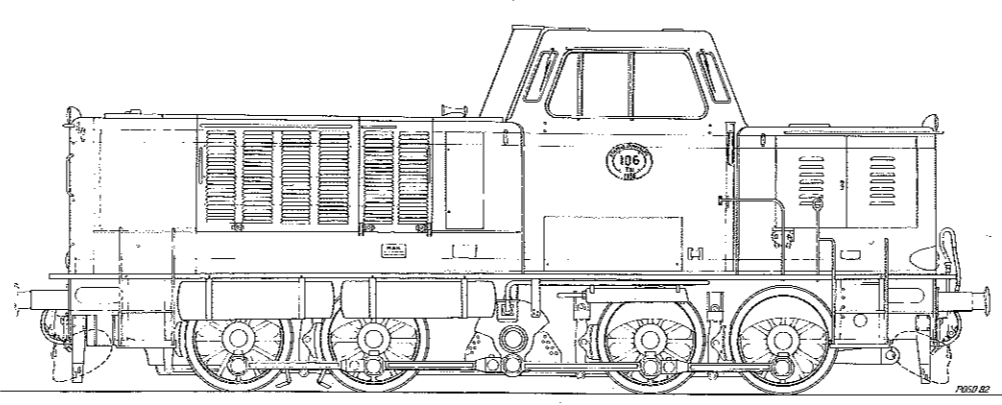
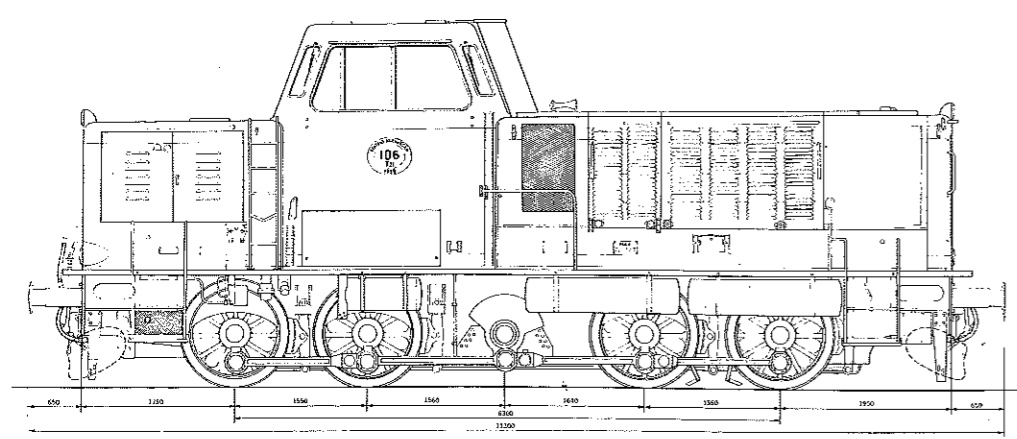
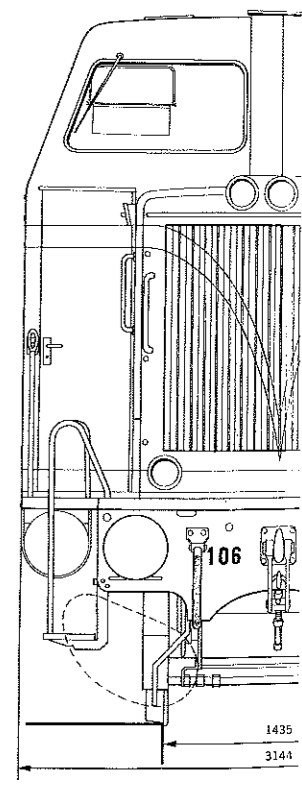
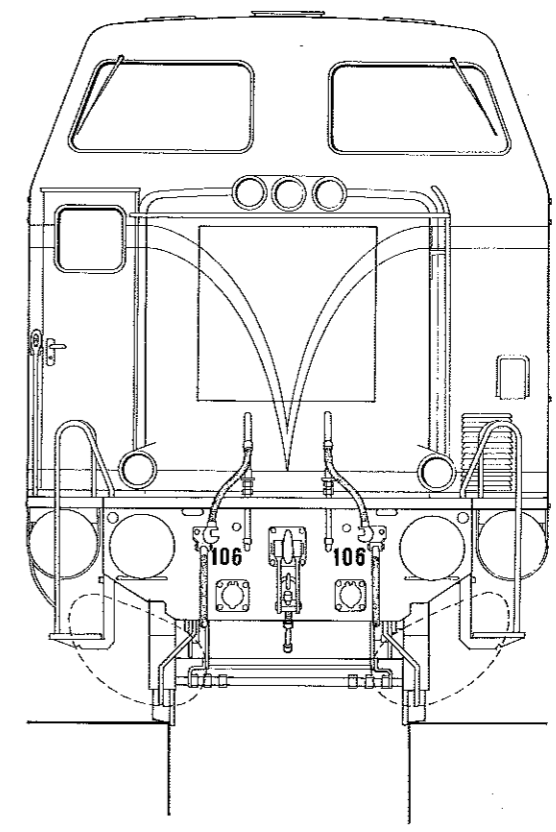
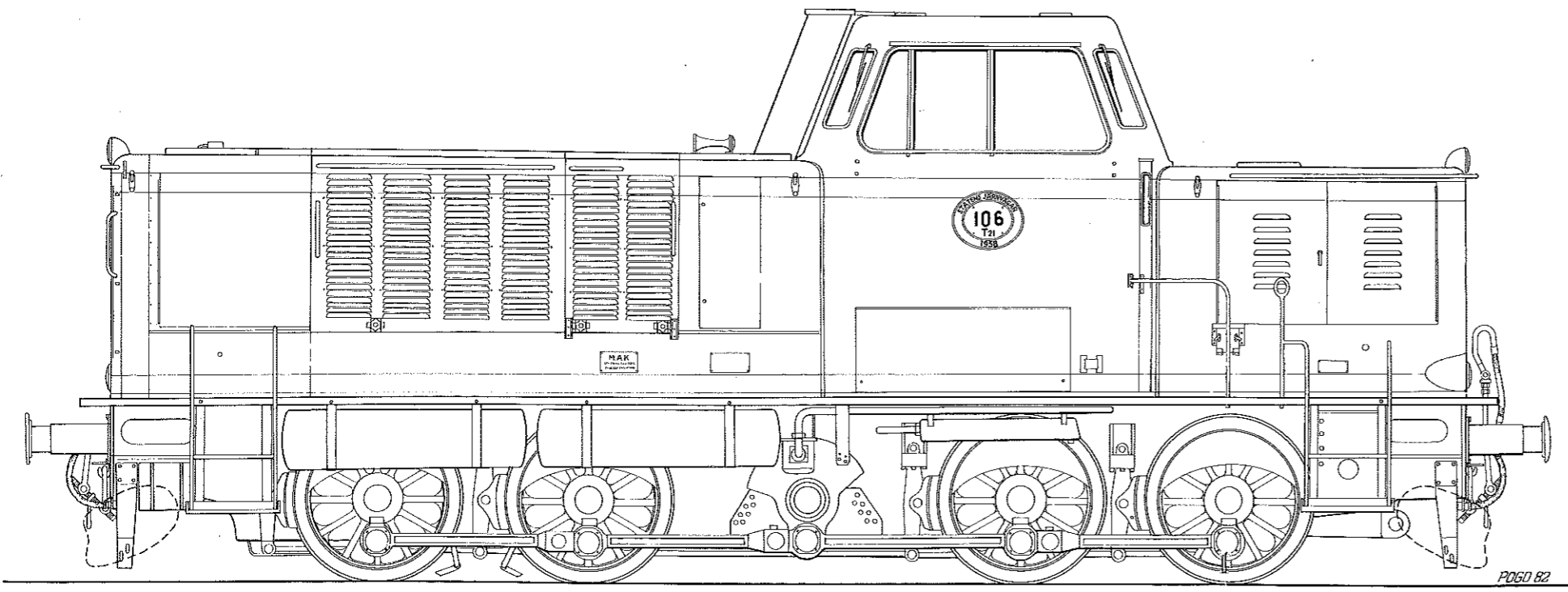
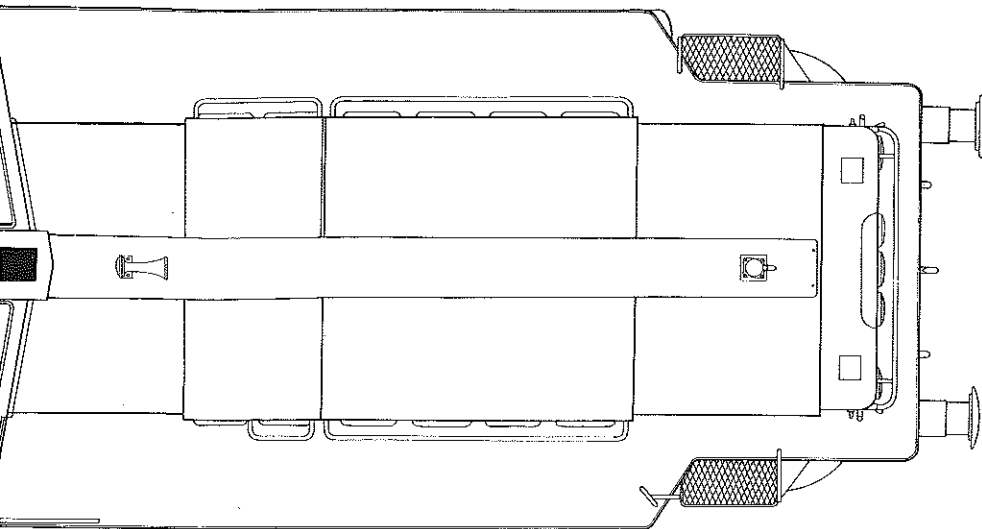

ingarna utförda i skala 1:45 (O), 1:87 (H0)
1:60 (N) av Per-Olov Olovsson

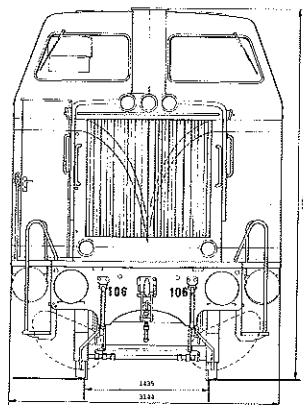
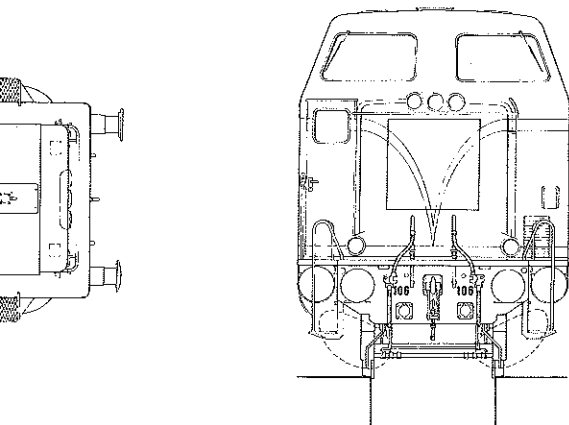
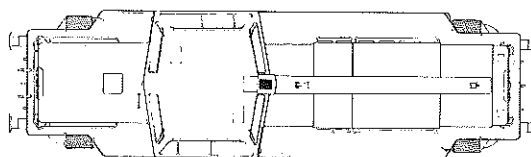
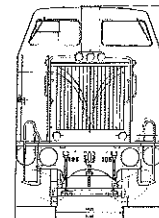
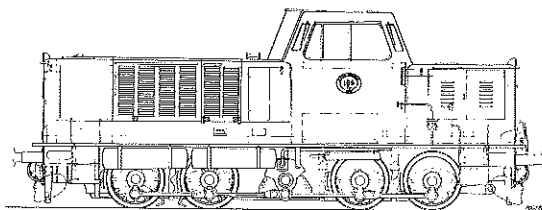
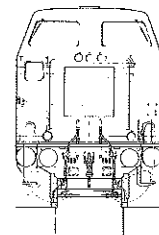
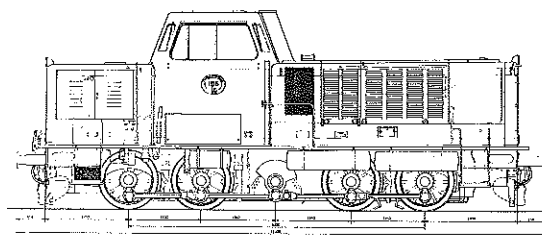
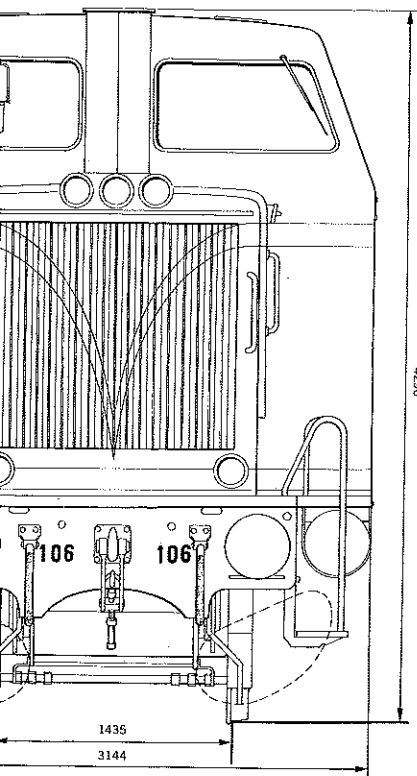

Några tekniska data
 Motoreffekt 800 hp
 Drivhjulsdiameter 1 255 mm
 Dragkraft 17,2 Mp ton
 Tjänstevikt 56,8 ton